

colortile
ceramics & innovation



**600x1200mm
Glazed Vitrified Tiles**

LUME



QUIET

Inspired by nature's nuanced surfaces and refined by modern craftsmanship, Lume transforms ceramic tiles into timeless design statements for contemporary spaces.

ELEGANCE

SHAPED

Born at the intersection of nature's raw beauty and modern design sensibilities, the Lume celebrates intricate surface and luminosity. Each tile captures varying intensities of light, creating an ever-evolving visual experience throughout the space.

An exploration of radiance and intricate details, Lume by Colortile is where light, details, and design converge.

BY LIGHT

& FORM

A hand holding a bouquet of baby's breath flowers against a textured, light-colored background. The word "LUME" is written in a serif font in the upper left quadrant of the image.

LUME

A SANTUARY OF LIGHT AND LUXURY

Explore a lustrous collection rich in radiant and artistic details.

A collection designed for modern sensibilities - The Lume by the house of Colortile enriches modern spaces with warmth, meticulous detail, and quiet luxury. Ideal for home and commercial settings, the collection's tiles adapt effortlessly, infusing environments with subtle character and serene sophistication.

Surface details in the collection are not merely there; they are revealed. Every detail feels like contour, grain, and texture appear sculpted from within, evoking a sense of depth and intention. Crafted for discerning eyes and refined touch, these tiles invite closer interaction, where light glides softly across surfaces and details emerge with quiet confidence.

Experience elegance that speaks softly and lasts forever. Lume is not about excess; it is about intention. A collection that celebrates quiet beauty, refined details, and enduring design crafted to illuminate spaces with grace, depth, and timeless appeal.



SURFACE:
VELVET SINKER

The Velvet Sinker surface delivers a smooth, subtly detailed experience. Its gentle sheen enhances light reflection without overpowering, and the artisanal sinker details harmonize well with balanced interior languages.



SURFACE:
VELVET

Velvet is a refined surface finish that embodies luxury. Exceptionally smooth to the touch, it delivers a soft, silky feel with a gentle sheen that enhances the depth and richness.

TECHNICAL ATTRIBUTES & BENEFITS

**Hygienic,
antimicrobial surface,
that is food contact safe.**

The surfaces of the collection are non-porous, making them antimicrobial and safe for contact with food.



Maintain hygienic spaces effortlessly with Colortile's antimicrobial surfaces that resist microbial buildup, making them safe to use in your kitchen and various places.

**Non-porous,
non-absorbent surface
that resists water & stains.**

Forget stains, water spots, and more with non-absorbent surfaces from Colortile.



The tiles' non-porous properties and exceptional glaze make them resistant to water and stains, allowing you to maintain a spotless home and space.

**Resistant to
scratches and abrasions
from everyday use.**

Say goodbye to a grazed and roughened surface with scratch-resistant surfaces



Engineered using high-quality raw materials and industry-leading technology and processes, Colortile surfaces are highly resistant to scratches and abrasions.

**Resistant to
damage arising from
temperature change.**

These tiles do not get damaged by fluctuating temperatures or use in the kitchen.



Ready to brave sudden temperature change, Colortile tile does not get damaged when you place something hot or cold on it or in spaces experiencing temperature fluctuations.

LUME

Lume is a thoughtfully curated ceramic collection designed to complement modern spatial narratives, balancing warmth, attention to detail, and understated luxury. Whether used in residential interiors or commercial environments, the collection's tiles adapt seamlessly, enhancing spaces with character and calm sophistication.

13

COLORS

Inspired by natural terrains and mineral-rich landscapes, Lume presents a palette of 13 carefully curated colors.

1

SIZE

600x1200mm
60x120cm

2

SURFACES

Velvet Sinker
Velvet

From muted earth tones to refined neutral hues, a versatile size, and two elegant surfaces, the collection offers versatility for a harmonious interior style.

RECOMMENDED SPACES



Hall & Corridor



Commercial Building



Hotel, Café & Restaurant



Industry



Super Market & Mall



Religious Place



School & College



Spa & Wellness Centre



Gymnasium



Residential



Hospital



Airport

PRODUCT HIGHLIGHTS



Long Durability



Easy to Clean



Impact Resistance



Easy Installation



Hygienic Surface



Fire Resistance



Chemical Resistance



Thermal Shock Resistance



Frost Resistance



Low Water Absorption



Dimensional Stability



Crazing Resistance

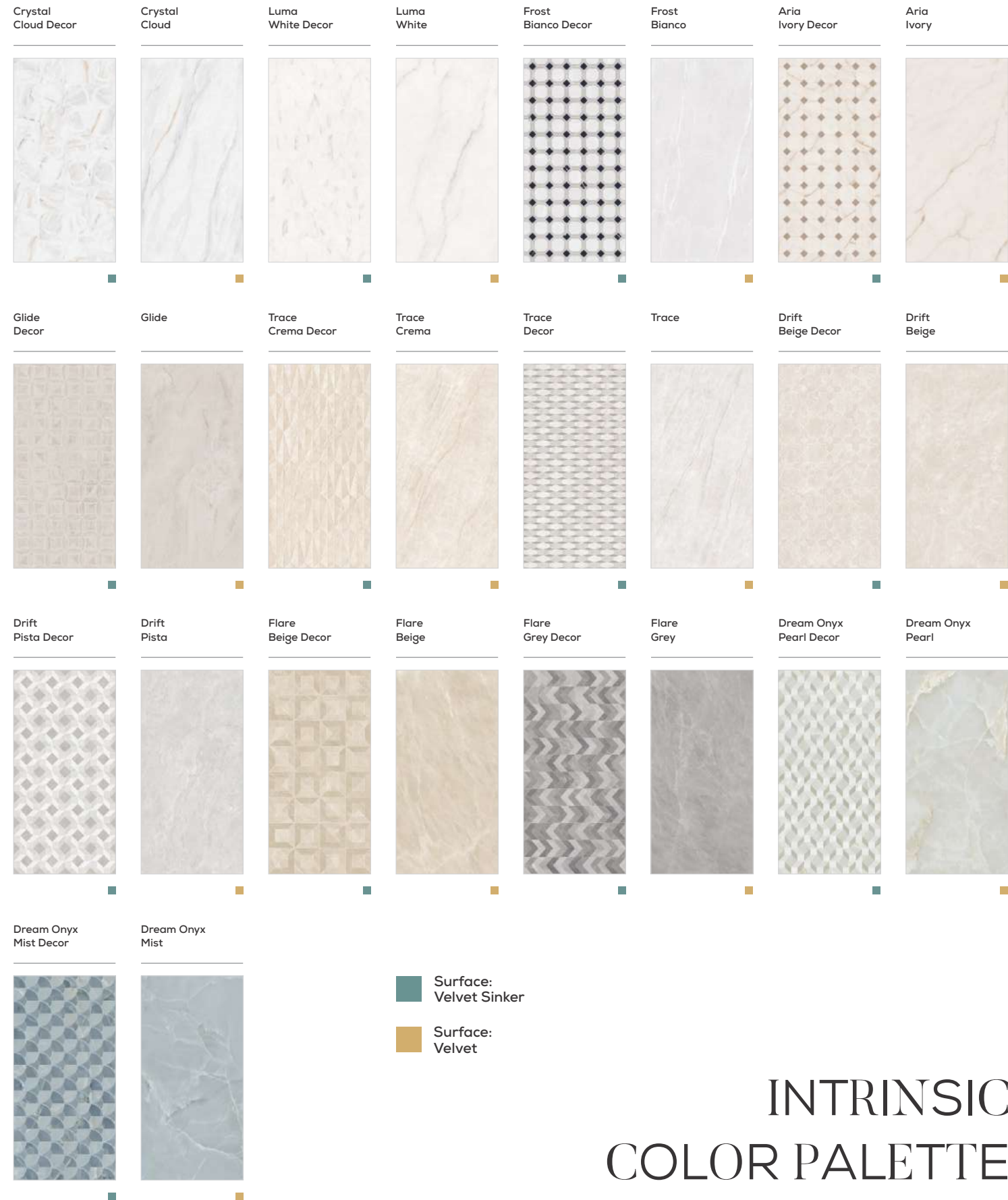

INTRINSIC COLOR PALETTE

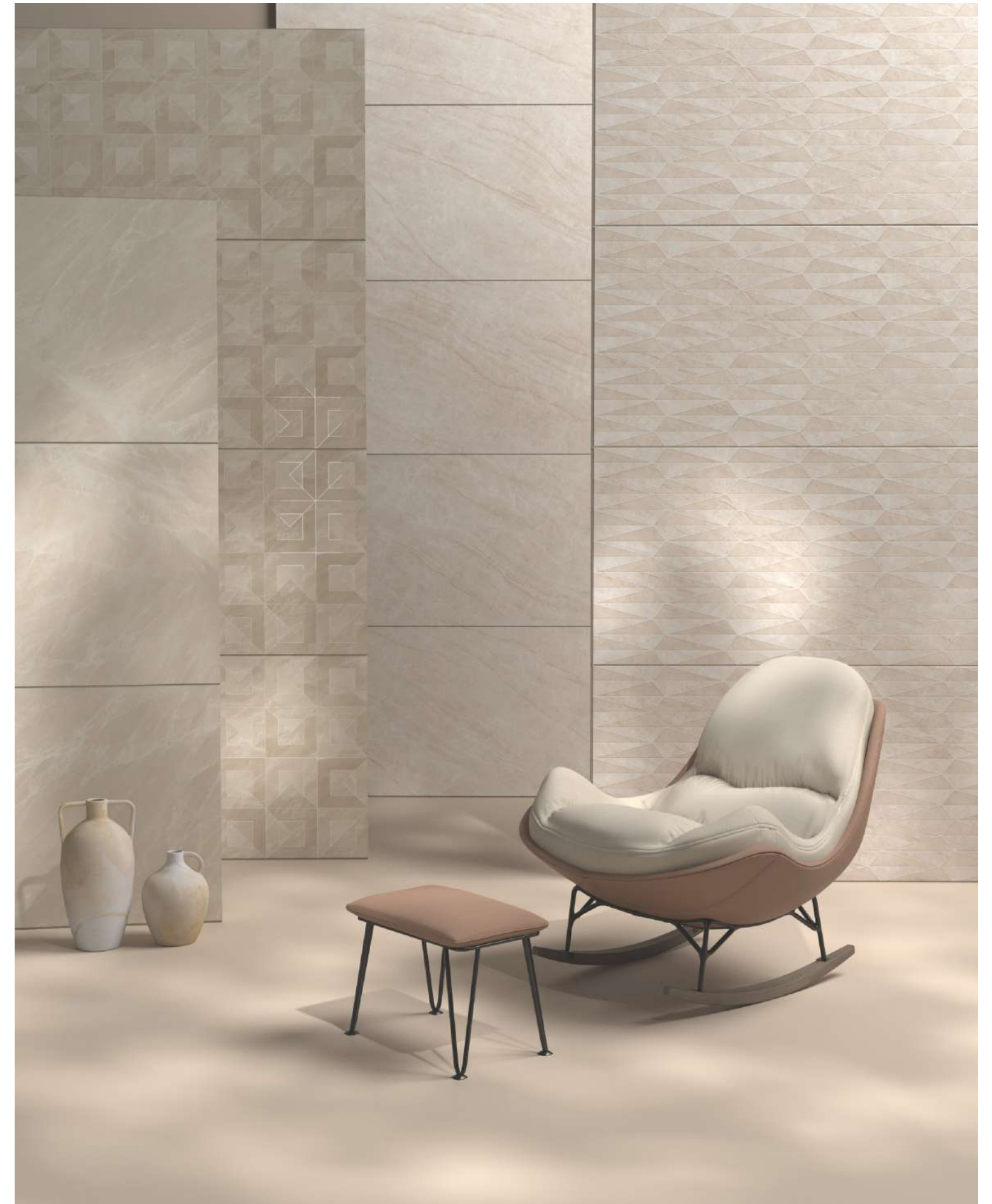

DESIGN ETCHED IN ELEGANCE



Subtle details meet contemporary form, creating decor that whispers luxury.





RESTAURANT

Crystal Cloud Decor & Crystal Cloud

Size_ 600x1200mm

Click Here

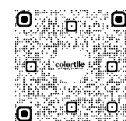

[← Click for the Index](#)



Size



600x1200mm

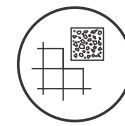

Decorative
Designs



Crystal Cloud Decor



Surface: **Velvet Sinker**

2 - Random Faces

Crystal Cloud



Surface: **Velvet**

4 - Random Faces

Crystal Cloud Decor & Crystal Cloud

Size_ 600x1200mm

Every line reflects thoughtful craftsmanship and an eye for refined design.



DETAILS
THAT TELL
A STORY

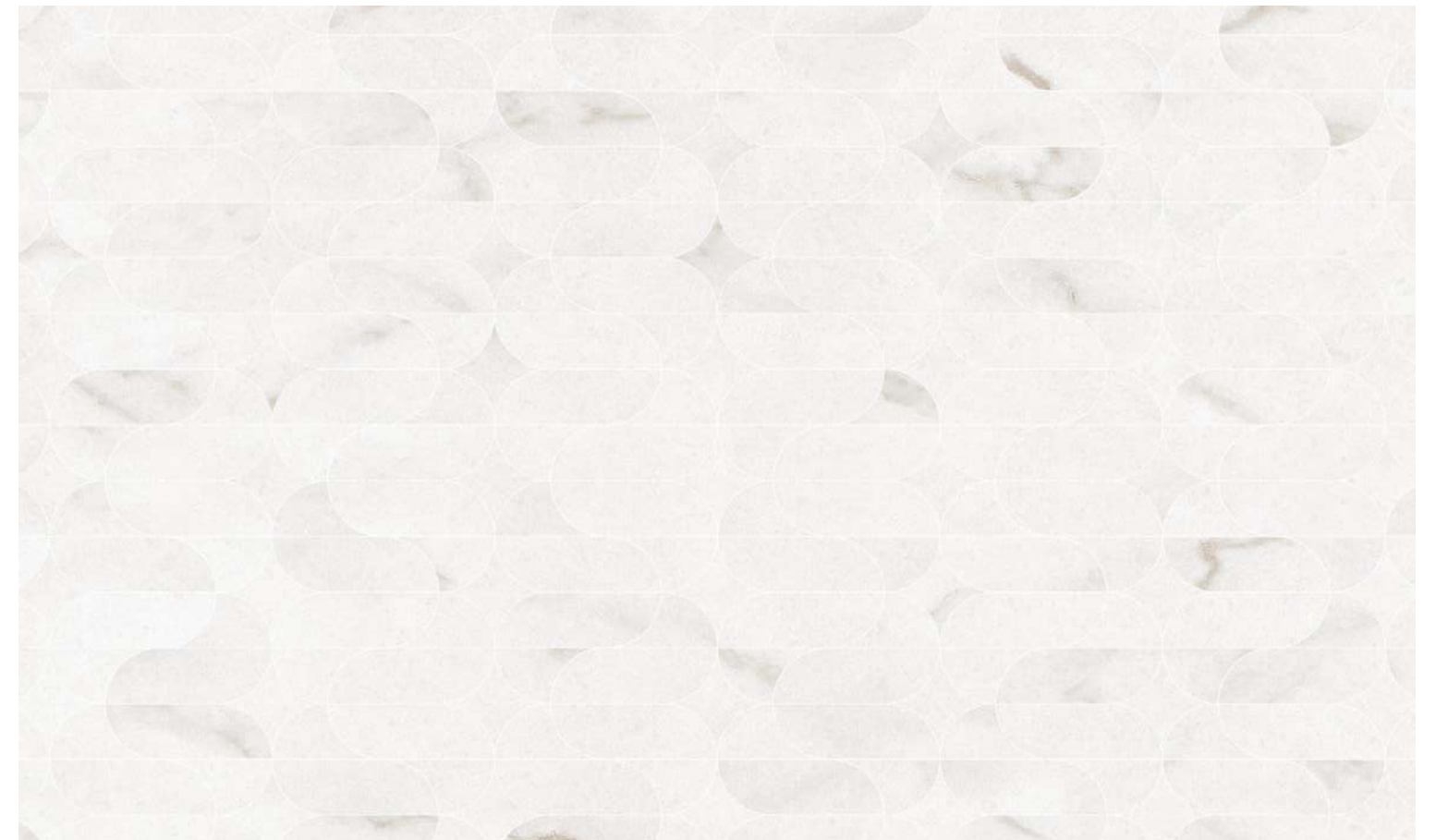

LIVING ROOM



Luma White Decor & Luma White
Size_ 600x1200mm

Click Here

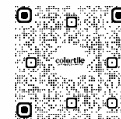

[← Click for the Index](#)



Size

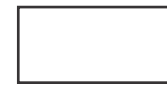

600x1200mm

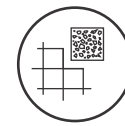

Decorative
Designs



Luma White Decor

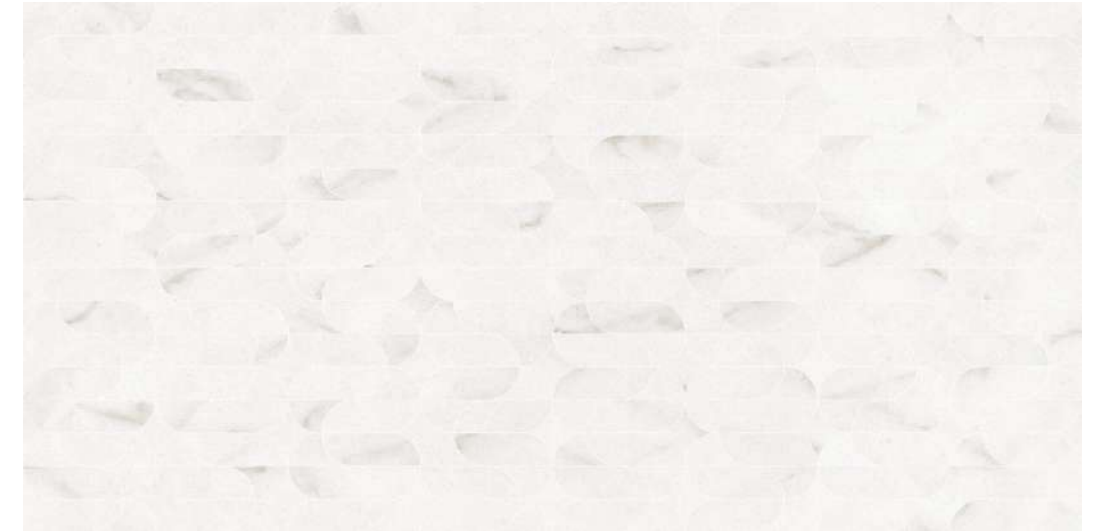

Surface: **Velvet Sinker**

2 - Random Faces

Luma White



Surface: **Velvet**

8 - Random Faces

Luma White Decor & Luma White

Size_ 600x1200mm

ELEGANCE BENEATH THE SURFACE

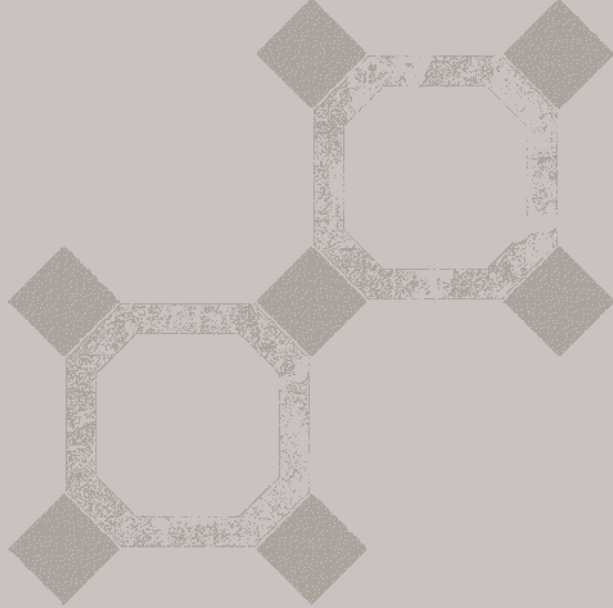

Intricate details reveals
themselves gradually, rewarding
those who appreciate fine detail.

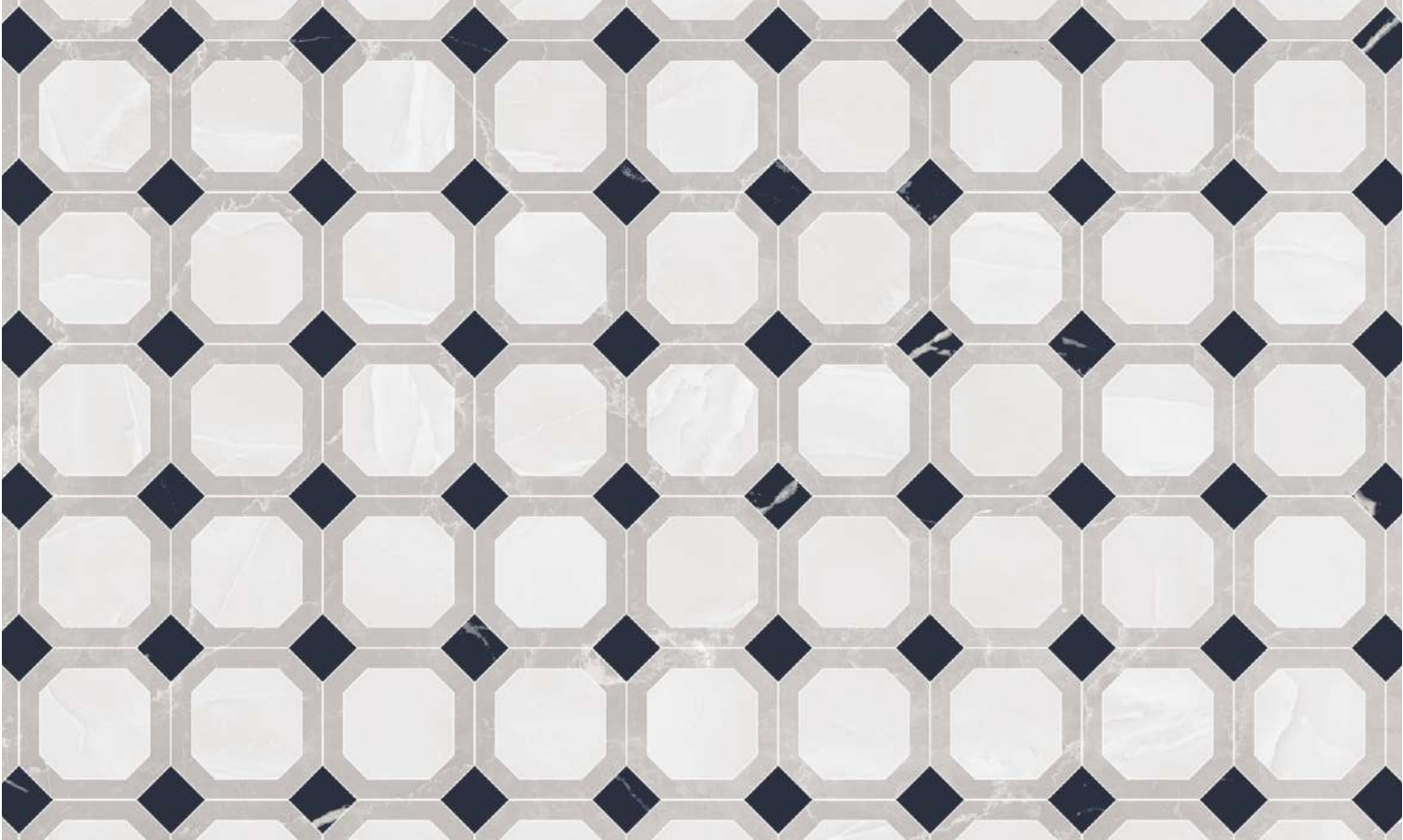

BATH SPACE



Frost Bianco Decor & Frost Bianco
Size_ 600x1200mm

Click Here



← Click for the Index



Size

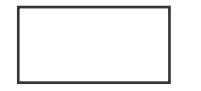

600x1200mm

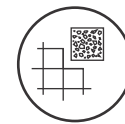

Decorative
Designs



Frost Bianco Decor

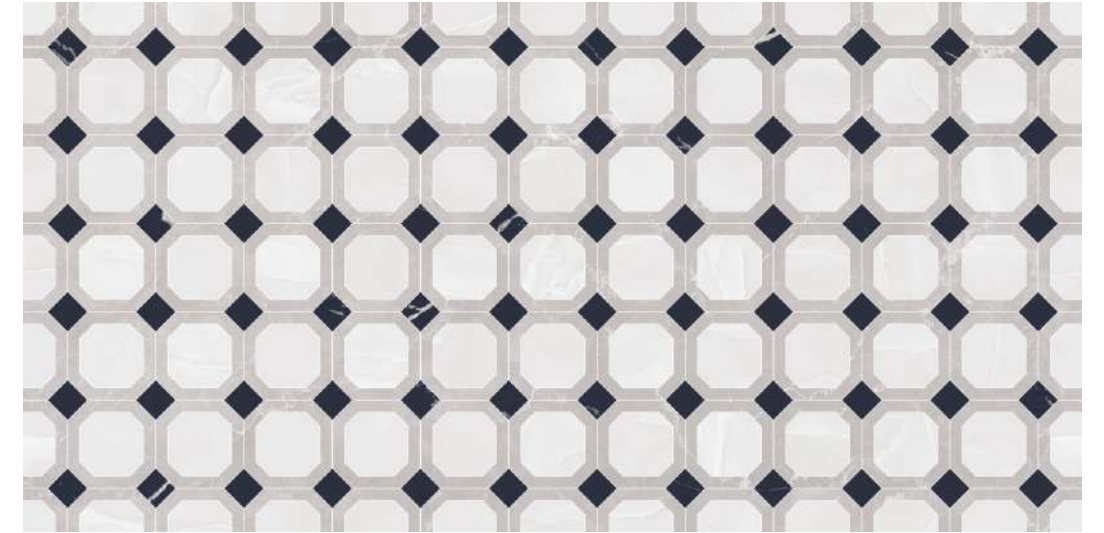

Surface: **Velvet Sinker**

2 - Random Faces

Frost Bianco



Surface: **Velvet**

6 - Random Faces

Frost Bianco Decor & Frost Bianco

Size_ 600x1200mm

Designs that borrow from
timeless sculptural techniques,
reimagined for modern spaces.

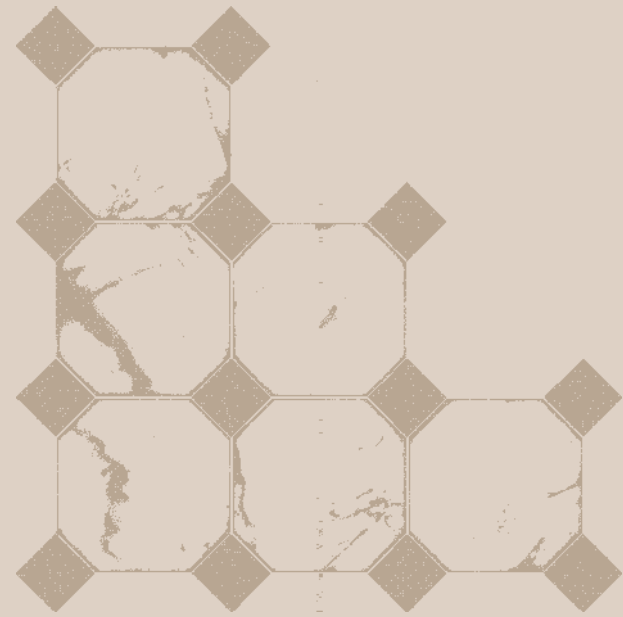

INSPIRED
BY THE ART
OF CARVING





POWDER ROOM

Aria Ivory Decor & Aria Ivory
Size_ 600x1200mm

[Click Here](#)

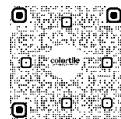

[← Click for the Index](#)



Size



600x1200mm

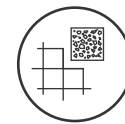

Decorative
Designs



Aria Ivory Decor



Surface: **Velvet Sinker**

2 - Random Faces

Aria Ivory



Surface: **Velvet**

6 - Random Faces

Aria Ivory Decor

Size_ 600x1200mm

A CANVAS OF QUIET LUXURY



Subtle surfaces with motifs that feel carved come together in understated sophistication.



COCKTAIL BAR



Glide Decor & Glide
Size_ 600x1200mm

Click Here



[← Click for the Index](#)



Size



600x1200mm

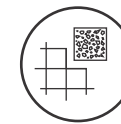

Decorative
Designs



Glide Decor



Surface: **Velvet Sinker**

2 - Random Faces

Glide



Surface: **Velvet**

8 - Random Faces

Glide Decor & Glide

Size_ 600x1200mm

Tiles that feel shaped by hand, designed to endure beyond trends.



SCULPTURAL
TEXTURES,
TIMELESS APPEAL



BOUTIQUE



Trace Crema Decor & Trace Crema

Size_ 600x1200mm

[Click Here](#)



[← Click for the Index](#)



Size

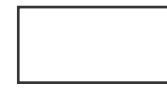

600x1200mm

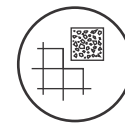

Decorative
Designs



Trace Crema Decor



Surface: **Velvet Sinker**

2 - Random Faces

Trace Crema



Surface: **Velvet**

6 - Random Faces

Trace Crema Decor & Trace Crema

Size_ 600x1200mm

WHEN SURFACES BECOME ART



Intricate aesthetics that elevate walls and floors into visual statements.

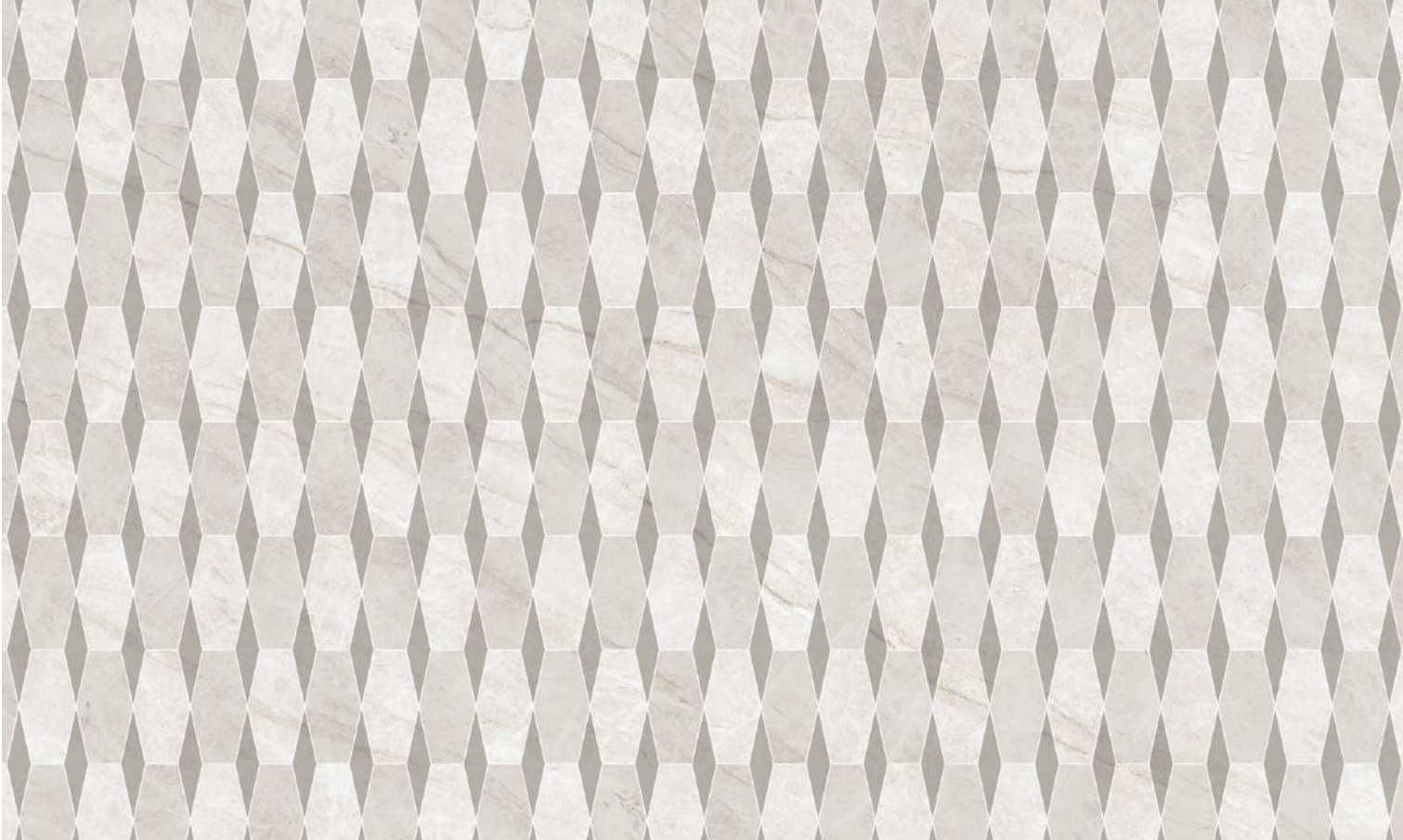



DRAWING ROOM

Trace Decor & Trace
Size_ 600x1200mm

[Click Here](#)



[← Click for the Index](#)



Size



600x1200mm

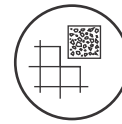

Decorative
Designs

Trace Decor

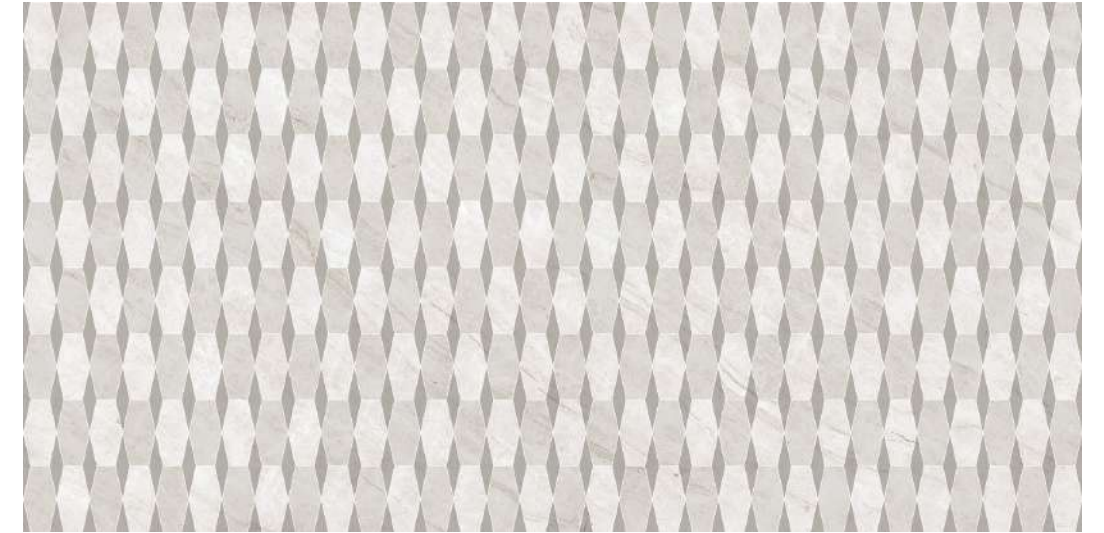

Surface: **Velvet Sinker**

2 - Random Faces

Trace



Surface: **Velvet**

6 - Random Faces



Trace Decor & Trace

Size_ 600x1200mm



Every pattern is deliberate,
every detail a tribute to
refined craftsmanship.

ETCHED WITH INTENTION AND CARE



SHOWROOM



Drift Beige Decor & Drift Beige
Size_ 600x1200mm

Click Here

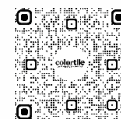

[← Click for the Index](#)

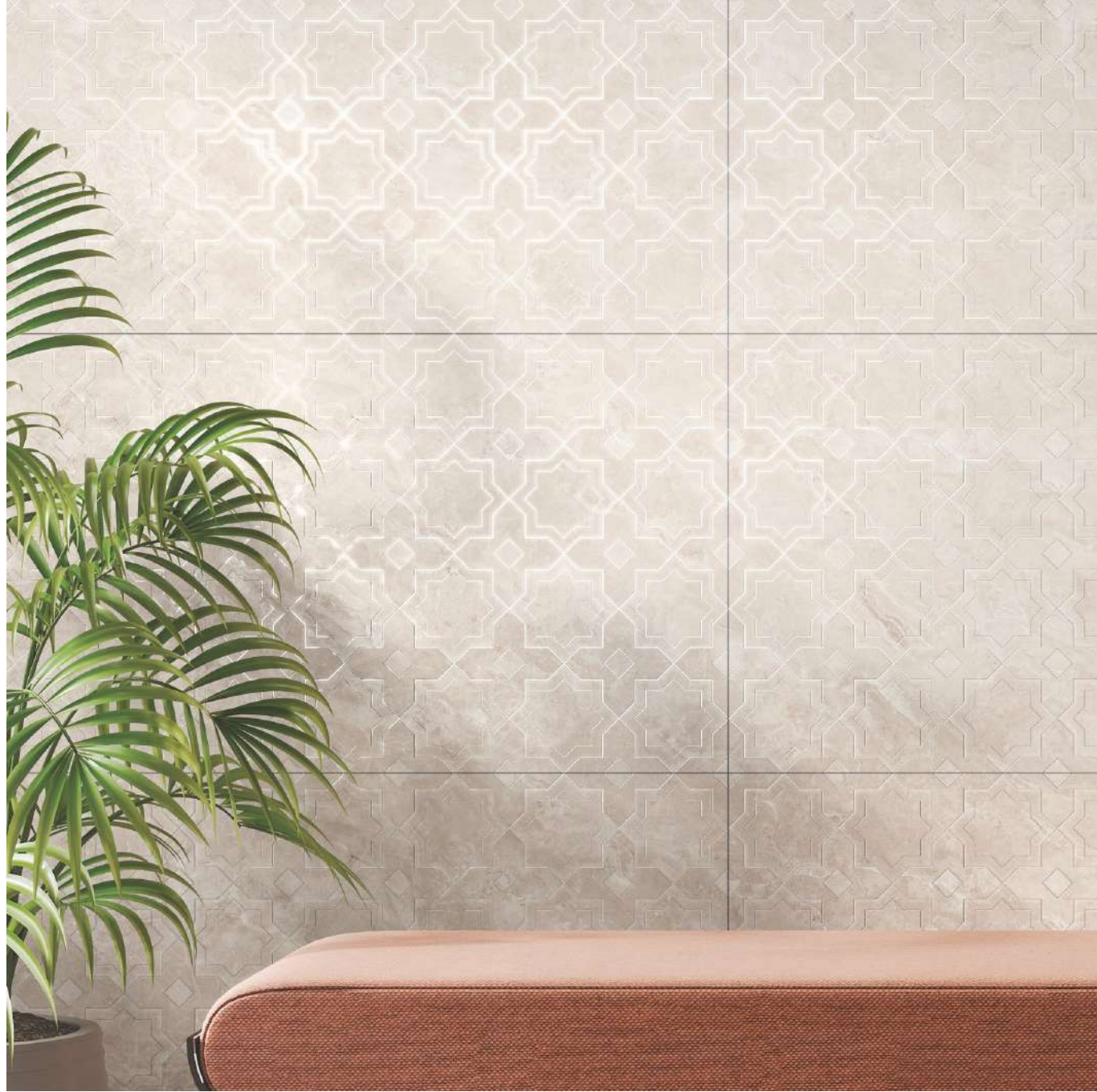

Size

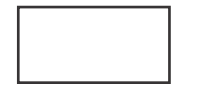

600x1200mm

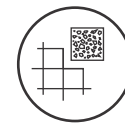

Decorative
Designs



Drift Beige Decor



Surface: **Velvet Sinker**

2 - Random Faces

Drift Beige



Surface: **Velvet**

6 - Random Faces

Drift Beige Decor

Size_ 600x1200mm

REFINEMENT,
CARVED IN
AND OUT



Graceful etchings and sculpted depth combine to create a truly elevated decor experience.



BATH SPACE



Drift Pista Decor & Drift Pista
Size_ 600x1200mm

Click Here



[← Click for the Index](#)



Size



600x1200mm

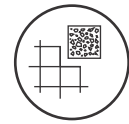

Decorative
Designs



Drift Pista Decor

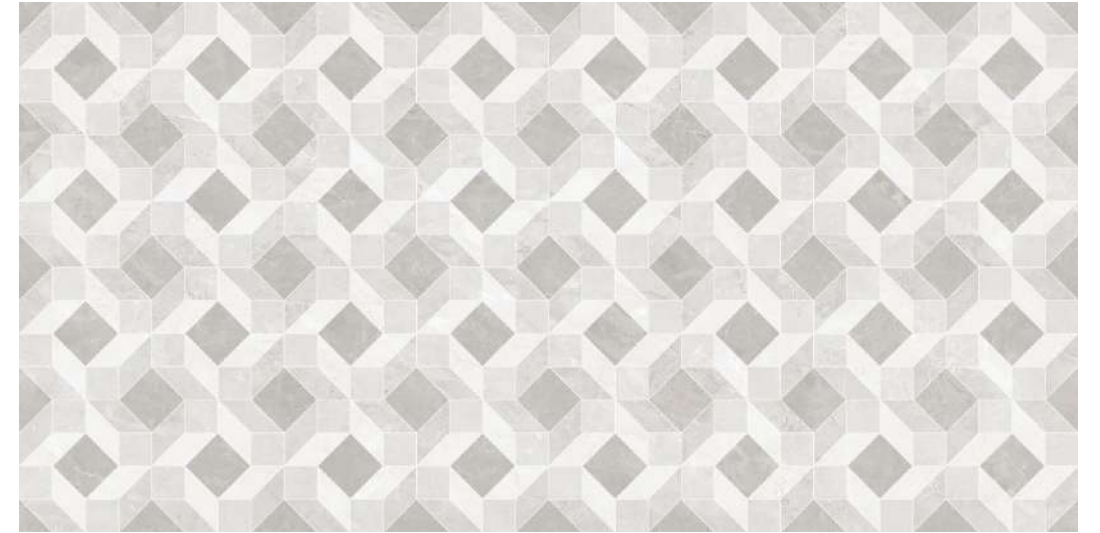

Surface: **Velvet Sinker**

2 - Random Faces

Drift Pista



Surface: **Velvet**

6 - Random Faces

Drift Pista Decor & Drift Pista

Size_ 600x1200mm

Experience intricacies,
craft that feels sculpted by
hand - carefully and ardently.



THE ELEGANCE OF FINE DETAILS

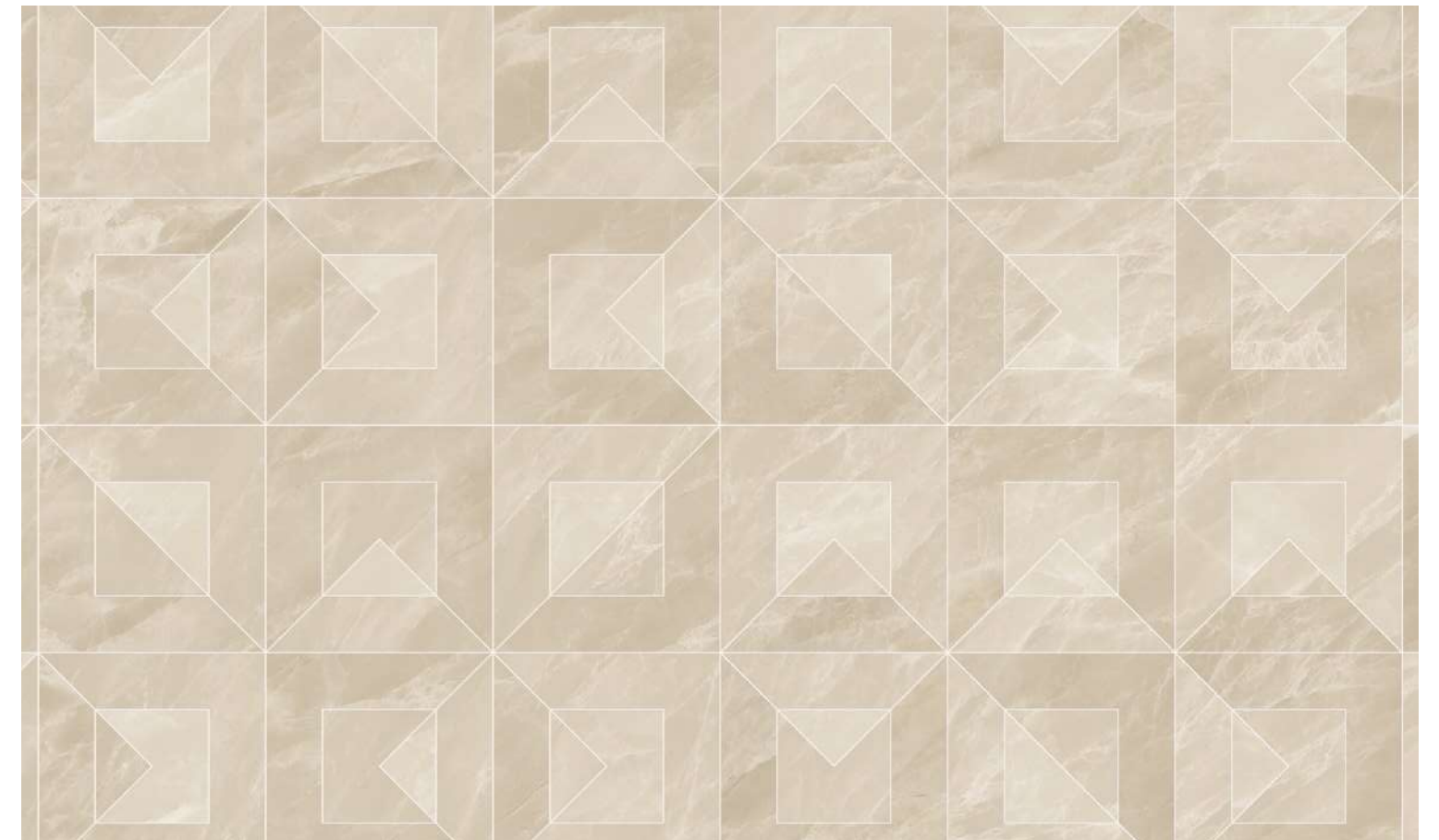



FINE DINE

Flare Beige Decor & Flare Beige
Size_ 600x1200mm

[Click Here](#)

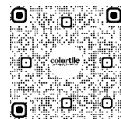

[← Click for the Index](#)



Size



600x1200mm

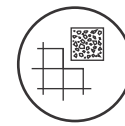

Decorative
Designs

Flare Beige Decor

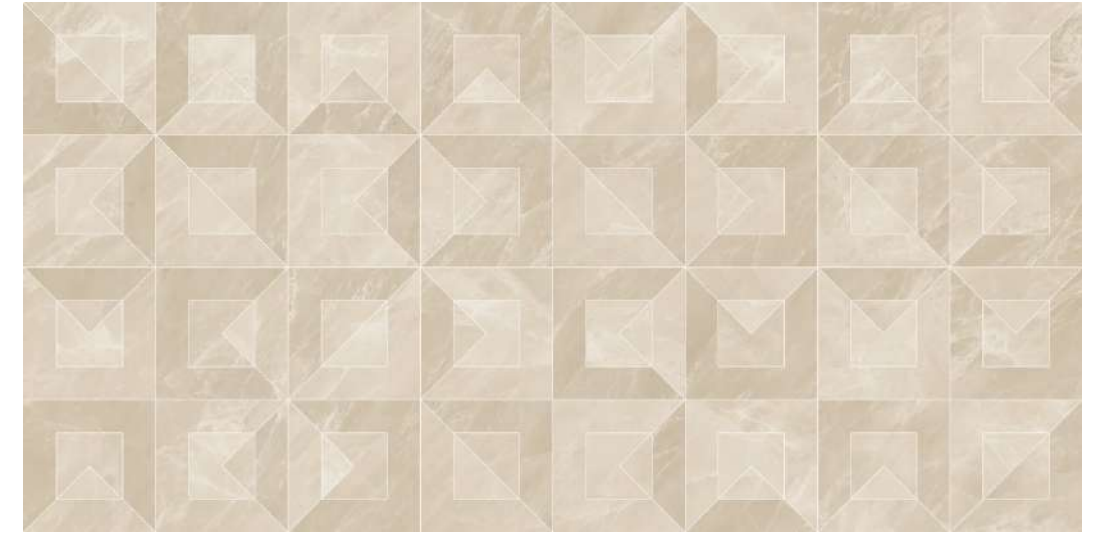

Surface: **Velvet Sinker**

2 - Random Faces

Flare Beige



Surface: **Velvet**

8 - Random Faces

Flare Beige Decor & Flare Beige

Size_ 600x1200mm

SCULPTED BY DESIGN AND INTENTION



Intricate patterns shaped
with precision, evoking the
poetry of carved stone and
refined artistry.



KITCHEN



Flare Grey Decor & Flare Grey
Size_ 600x1200mm

[Click Here](#)



[← Click for the Index](#)



Size

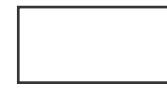

600x1200mm

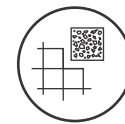

Decorative
Designs

Flare Grey Decor



Surface: **Velvet Sinker**

4 - Random Faces

Flare Grey



Surface: **Velvet**

8 - Random Faces

Flare Grey Decor & Flare Grey

Size_ 600x1200mm

Surfaces that echo the
finesse of hand-carved
craftsmanship, softly etched
to elevate every space.



WEIGHT OF TIME IN ART & ARTISTRY



LIVING ROOM



Dream Onyx Pearl Decor & Dream Onyx Pearl
Size_ 600x1200mm

[Click Here](#)



[← Click for the Index](#)



Size

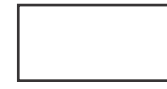

600x1200mm

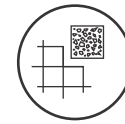

Decorative
Designs

Dream Onyx Pearl Decor

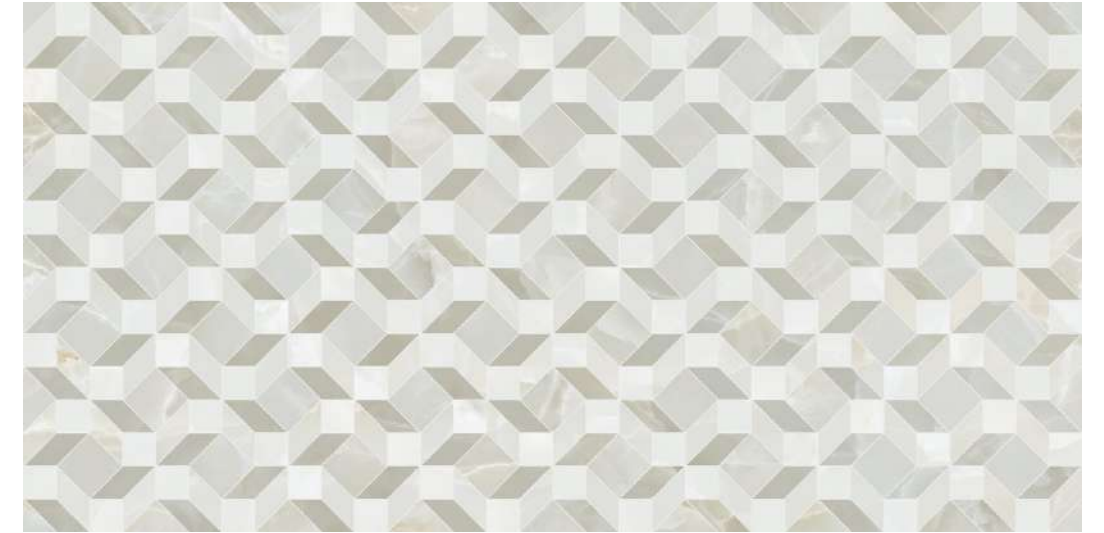

Surface: **Velvet Sinker**

2 - Random Faces

Dream Onyx Pearl



Surface: **Velvet**

8 - Random Faces

Dream Onyx Pearl Decor & Dream Onyx Pearl

Size_ 600x1200mm

SOFTLY CARVED. PERFECTLY DEFINED



An interplay of depth and delicacy that transforms surfaces into sculptural expressions.

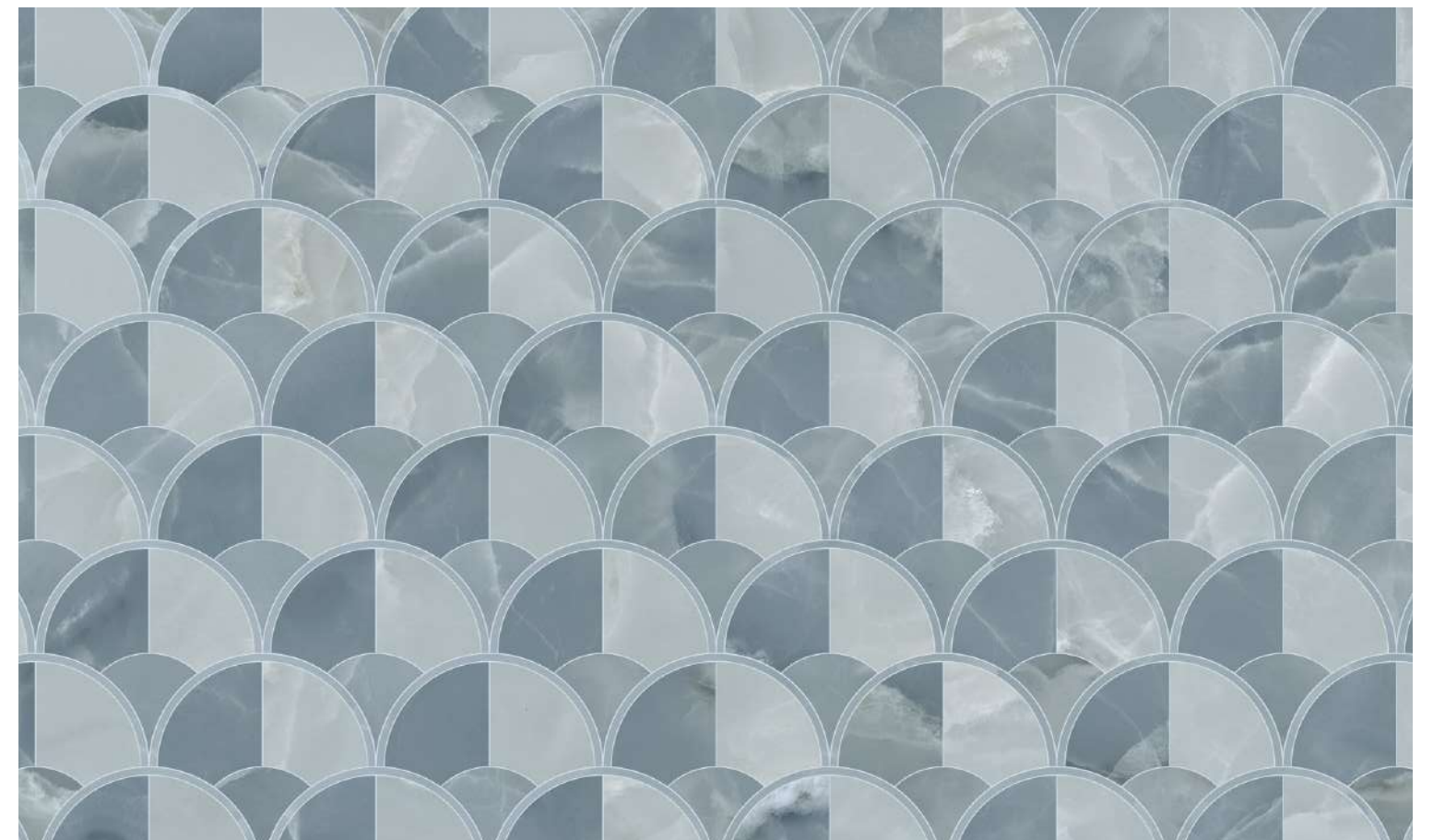



EN SUITE BATHROOM

Dream Onyx Mist Decor & Dream Onyx Mist

Size_ 600x1200mm

[Click Here](#)

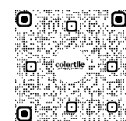

[← Click for the Index](#)



Size



600x1200mm

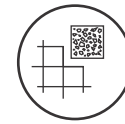

Decorative
Designs

Dream Onyx Mist Decor



Surface: **Velvet Sinker**

2 - Random Faces

Dream Onyx Mist



Surface: **Velvet**

8 - Random Faces

Dream Onyx Mist Decor

Size_ 600x1200mm

INSTALLATION

Step 1

Choose tiles that suit the room size and the style of your home. Smaller spaces are suited for bigger and pale-colored tiles to increase size and ventilation levels, but many kitchen and bathroom spaces have smaller tiles.

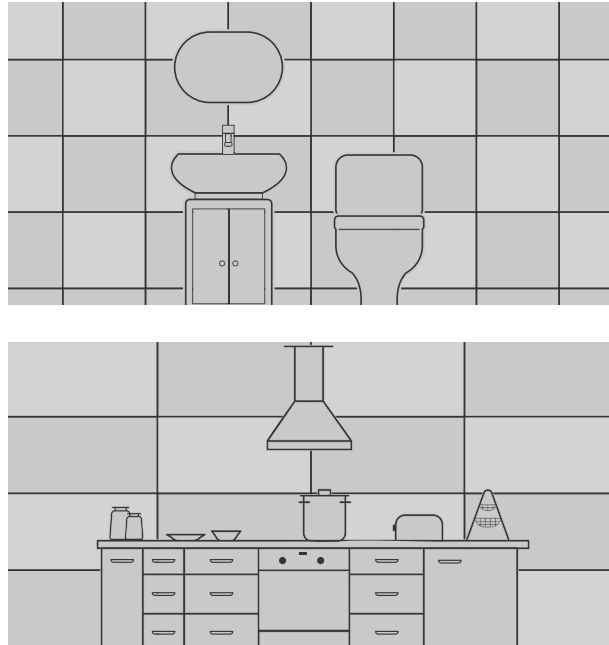

Step 2

Prioritize laying surface preparation through the proper soil layer compaction, subfloor leveling (PCC), completing brick and plasterwork, and waterproofing to protect your tiles from water seepage and long-term deterioration.

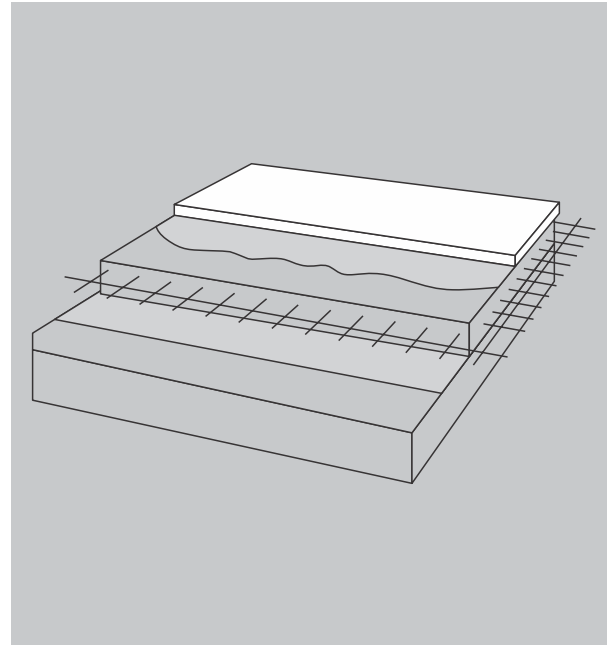

Step 3

Check that the surface is smooth and structurally sound before. Begin tile fixing work and ensure the site has proper lighting and ventilation.

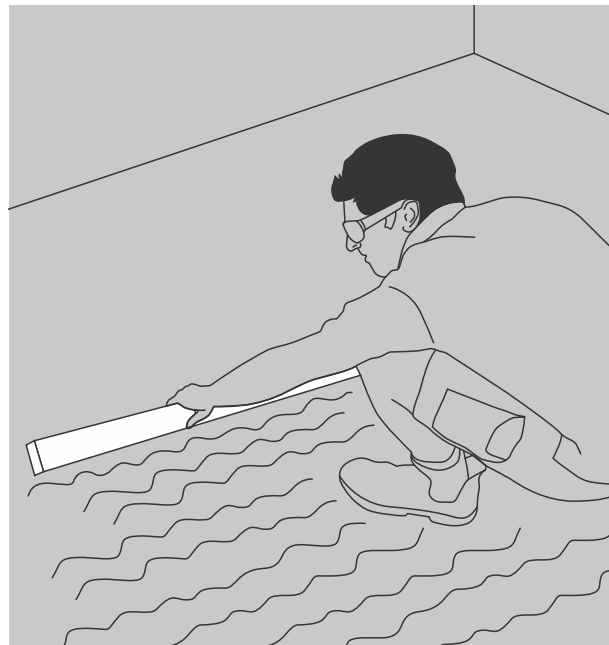

Step 4

Tiles should be set at right angles, and corners should not get bent. Prepare an adhesive (C2TE recommended > 2x2 tile size) plaster in advance by mixing water and mortar in a 1:6 ratio - follow this proportion to prevent cement joints from shrinking. Also, maintain minimal joints between two tiles and wipe off excess material.

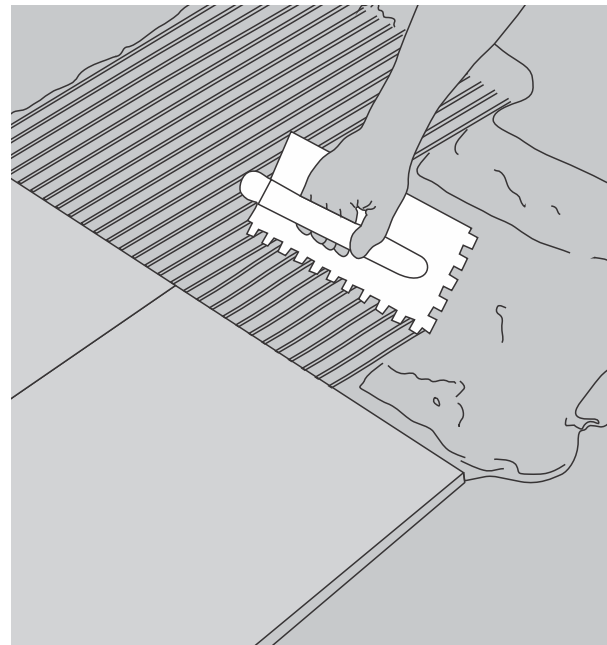

Step 5

Tiles should be placed equidistant to each other. Fill in joints with cement grout once installed.

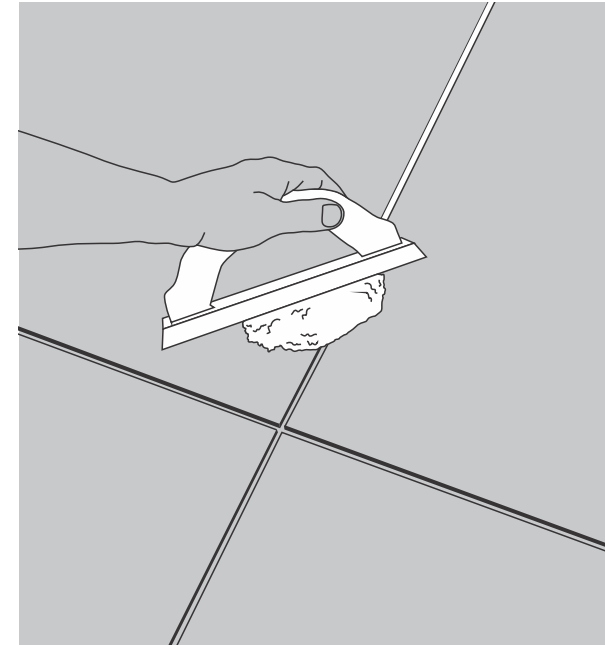

Step 6

Post installation, clean the tiling area with a wet mop and sweep the area. Floors with newly installed tiles should remain untouched for at least a week after fixing.



Note :

- Conduct tile fixing work with proper supervision to prevent defects such as cracks, breaking, and de-bonding, which can later incur extra costs. Tiling expenses should be covered in one stage of your home building.

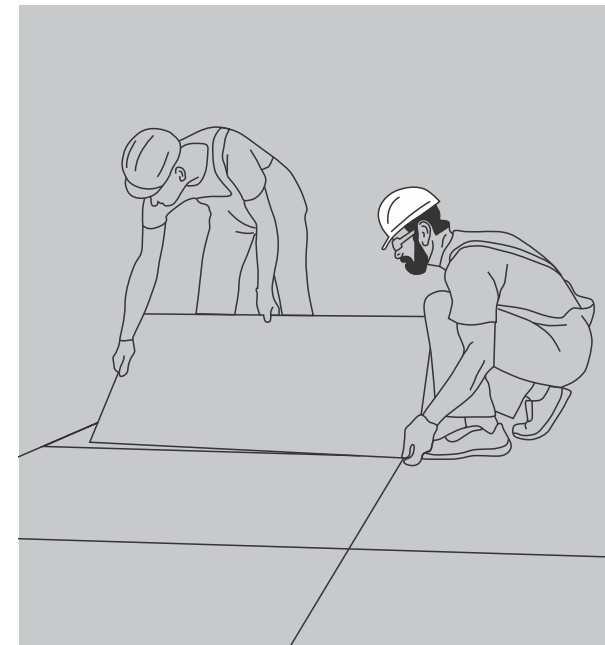

- Ensure that tiles are properly covered with fluted plastic sheets, plywood sheets, or P.O.P. during painting, electrical, or furniture work at the site to prevent any damage.

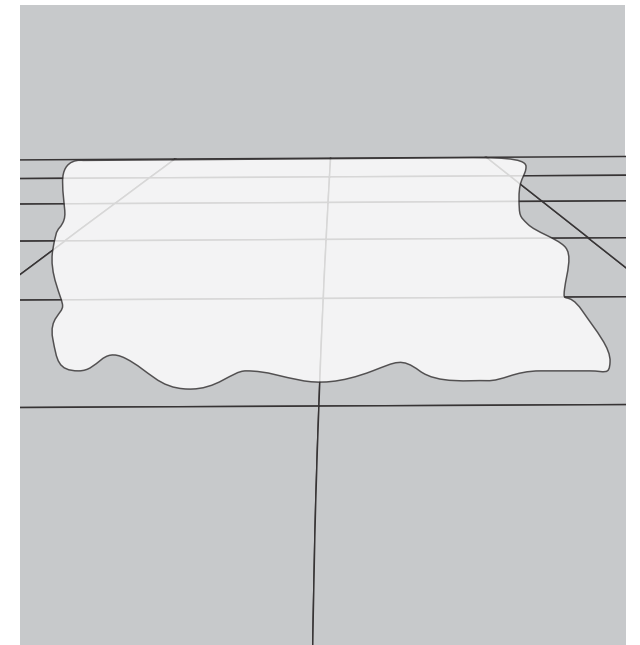

LUME DISPLAY PANELS FOR REAL-TIME EXPERIENCE

Step into a world of possibilities with our exclusive Lume Tiles Panels. Immerse yourself in the collection's finishes and details, and effortlessly visualize how each combination can transform your space.

LUME
600x1200mm

Surfaces : Velvet Sinker, Velvet



Crystal Cloud Decor &
Crystal Cloud



Luma White Decor &
Luma White



Frost Bianco Decor &
Frost Bianco



Aria Ivory Decor &
Aria Ivory



Glide Decor &
Glide



Trace Crema Decor & Trace Crema



Trace Decor & Trace



Drift Beige Decor & Drift Beige



Drift Pista Decor & Drift Pista



Flare Beige Decor & Flare Beige



Flare Grey Decor & Flare Grey



Dream Onyx Pearl Decor & Dream Onyx Pearl



Dream Onyx Mist Decor & Dream Onyx Mist

TECHNICAL SPECIFICATION OF 600x1200mm

Colortile Quality Standards

Standards according to ISO 13006: Annex G - EN 14411: Annex G. Dry - Pressed Ceramic Tiles. Group BIa (Eb 0.5%)

Technical Feature	Test Method	Requirements		Colortile Values			
		%	mm	%	mm		
Dimensions and Surface Quality	Length and Width	UNI EN ISO 10545-2	± 0.6%	± 2.0	± 0.20%	± 1.0	
	Thickness		± 5.0%	± 0.5	± 4.00%	± 0.4	
	Straightness of Sides		± 0.5%	± 1.5	± 0.20%	± 1.0	
	Rectangularity		± 0.5%	± 2.0	± 0.20%	± 1.2	
	Surface Flatness		A minimum of 95% of the tiles shall be free from visible defects that would impair the appearance of a major area of tiles.	± 0.5%	± 2.0	± 0.10%	± 1.0
	a) Centre curvature			± 0.5%	± 2.0	± 0.10%	± 1.0
	b) Edge curvature			± 0.5%	± 2.0	± 0.10%	± 1.0
c) Warpage	± 0.5%	± 2.0	± 0.10%	± 1.0			
Surface Quality		Compliant					
Physical Properties	Water Absorption	UNI EN ISO 10545-3	Eb ≤ 0.05% Individual maximum : 0.6% (absorbed water mass)		Eb ≤ 0.1% (absorbed water mass)		
	Breaking Strength	UNI EN ISO 10545-4	Min. 1300 N		≥ 1700 N		
	Modulus of Rupture		Average minimum 35 N/mm ² Individual minimum 32 N/mm ²		≥ 37 N/mm ²		
	Frost Resistance	UNI EN ISO 10545-12	Required		Compliant		
	Coefficient of Linear Thermal Expansion From Ambient Temperature to 100°C	UNI EN ISO 10545-8	Required		6 x 10 ⁻⁶ K ⁻¹ max		
	Scratch Hardness (Mohs scale)	EN 101	Declared by the producer		3 Depends on Finish & Color		
	Crazing Resistance	UNI EN ISO 10545-11	Declared by the producer		4 Cycle Pass		
Chemical Properties	Resistance to Staining	UNI EN ISO 10545-14	Minimum Class 3		5		
	Resistance to Household Chemicals and Swimming Pool Salts	UNI EN ISO 10545-13	Minimum GB		GA		
	Resistance to Low Concentrations of Acids and Alkalis		To be reported		GLA		
	Resistance to High Concentrations of Acids and Alkalis		To be reported		GHA		

PACKING DETAILS

Standard Pallet Packing

Pallet Type	Size	Thickness	pcs / Box	m ² / Box	kg / Box (Approx.)	Box / Pallet	m ² / Pallet	Pallet Size
A	600x1200mm	8.5mm	2 pcs	1.44 Sq. Mtr.	27.50 kg	64	92.16 Sq. Mtr.	1100x1100mm
B	600x1200mm	8.5mm	2 pcs	1.44 Sq. Mtr.	27.50 kg	33	47.52 Sq. Mtr.	675x1200mm
C	600x1200mm	8.5mm	2 pcs	1.44 Sq. Mtr.	27.50 kg	30	43.20 Sq. Mtr.	750x1200mm

Euro Pallet Packing

Pallet Type	Size	Thickness (Approx.)	pcs / Box	m ² / Box	kg / Box (Approx.)	Box / Pallet	m ² / Pallet	Pallet Size
A	600x1200mm	8.5mm	2 pcs	1.44 Sq. Mtr.	27.50 kg	32	46.08 Sq. Mtr.	800x1200mm

Packing Details

Size	Thickness (Approx.)	pcs / Box	m ² / Box	kg / Box (Approx.)
600x1200mm	8.5mm	2 pcs	1.44 Sq. Mtr.	27.50 kg



colortile
ceramics & innovation

Color Granito Pvt. Ltd.

At. Ratavirda Village,
Sartanpar Road, Tal. Wankaner - 363 621,
Dist. Morbi, Gujarat, INDIA

Cell: +91 95120 08815

info@colortile.in | www.colortile.in

